

Milano Design Week
2025

my home is ME

COLLECTION 2025

MERIDIANI

Collection 2025

SALONE DEL MOBILE

Roger / p.34

Roger Ghost / p.42

Jeanette / p.48

Frank / p.50

Adrian / p.56

Frank / p.60

Henry / p.64

Collection 2025

Un percorso coerente, di forme organiche e accoglienti, che continua a far dialogare semplicità e sartorialità, solidità materica e leggerezza visiva. La mano di Andrea Parisio firma una proposta che esprime il perfetto equilibrio tra classicità e contemporaneità, dove la modularità incontra la bellezza essenziale. Con soluzioni versatili, linee fluide e proporzioni calibrate, la collezione 2025 presenta arredi che si possono adattare con naturalezza a spazi di varie dimensioni, dall'ambiente domestico al mondo contract.

A coherent journey through organic, welcoming forms. Here, simplicity converses with tailoring craftsmanship, while material solidity balances visual lightness. Andrea Parisio's distinctive touch defines this collection. It achieves a perfect balance between classical and contemporary elements, creating a space where modularity embraces essential beauty. With versatile solutions, fluid lines and carefully calibrated proportions, the 2025 collection presents furnishings that naturally adapt to spaces of various dimensions, from domestic environments to contract settings.

my home is ME
01



4

Design Andrea Parisio



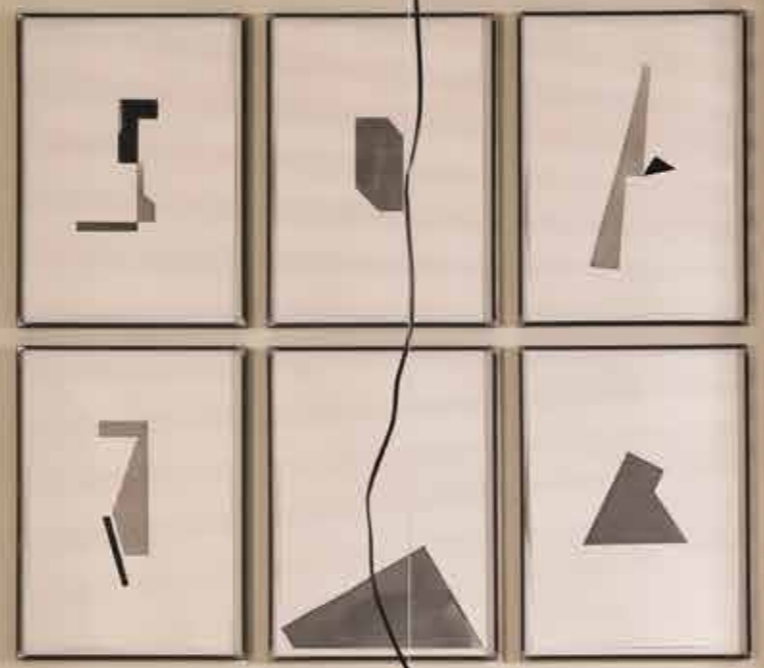







my home is ME
02



14

Design Andrea Parisio









my home is ME

03

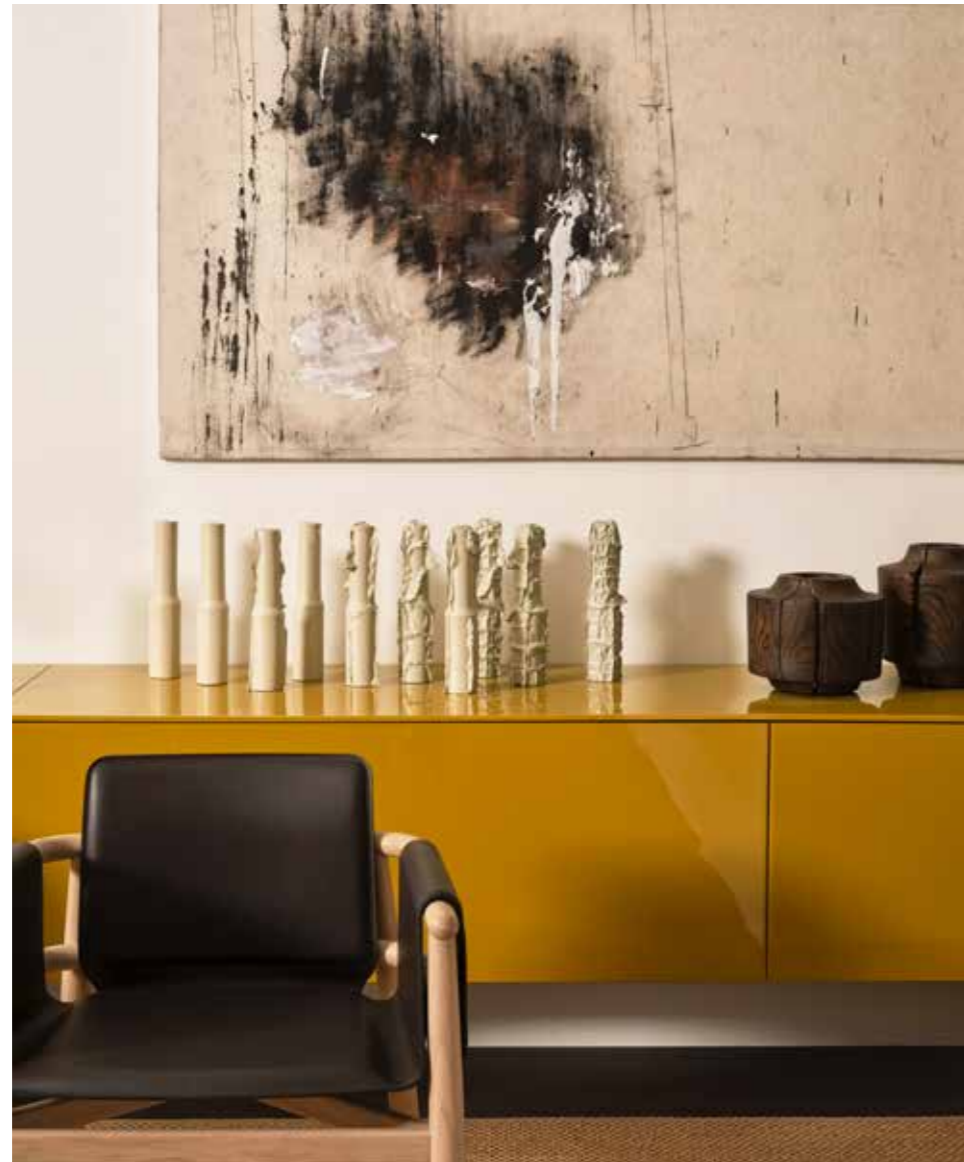

22

Design Andrea Parisio

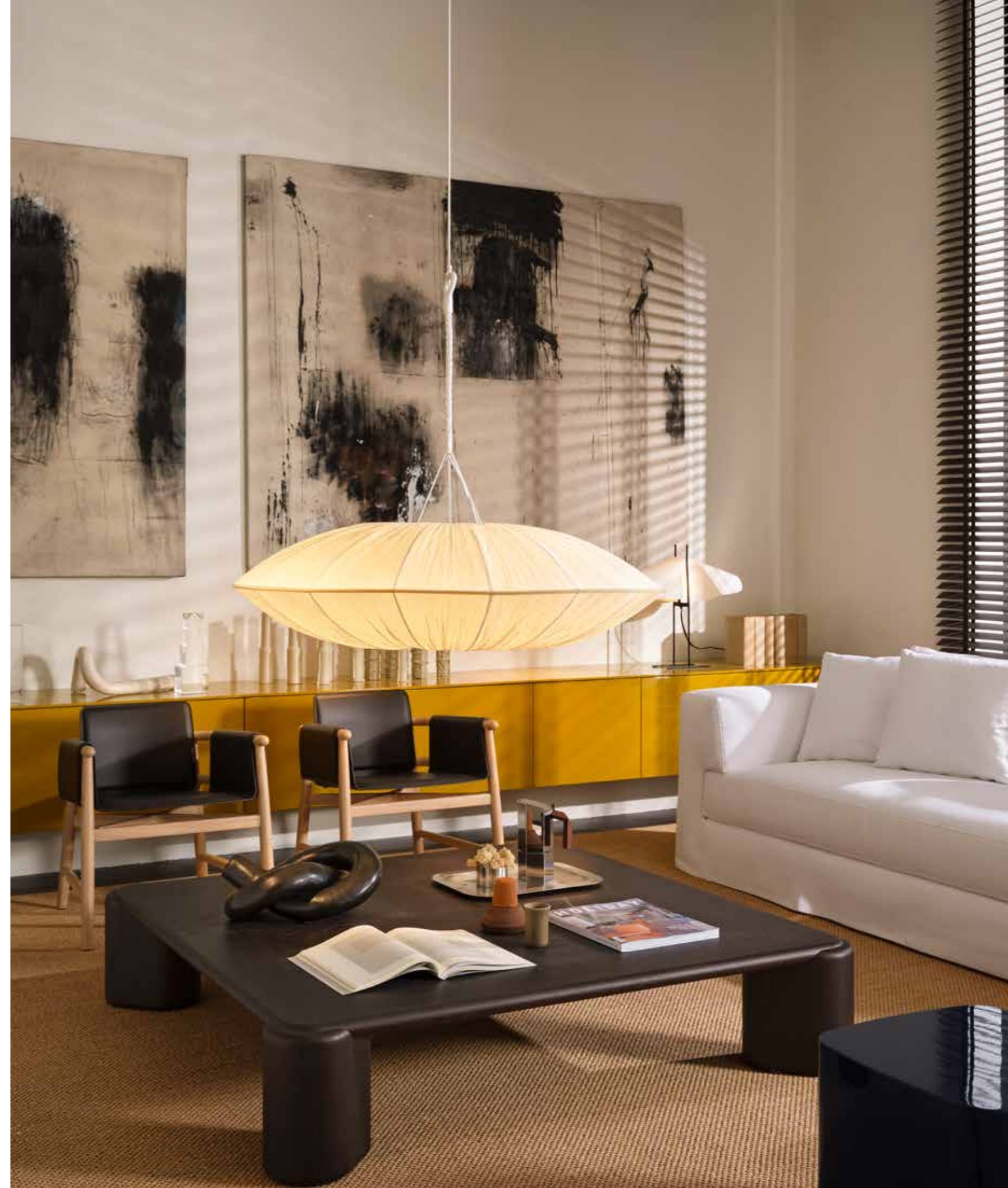









01

- p.04 BELT TB100 tavolo basso . low table
- p.05 JEANETTE love seat
MAX divano componibile . modular sofa
BELT TB100 tavolo basso . low table
GINO pouf
HARDY pensili . wall units
- p.06, 07 MAX divano componibile . modular sofa
RALF tavolo basso . low table
BELT TB100 tavolo basso . low table
GINO pouf
HARDY pensili . wall units
- p.08 OWEN 170 tavolo . table
TERESINA sedia . chair
- p.09 OWEN 170 tavolo . table
TERESINA sedie . chairs
AMADEUS pensile . wall unit
- p.10 TIMOTHY relax chaise
TIMOTHY divano . sofa
TIMOTHY tavoli bassi . low tables
CHARLOT pouf
- p.11 ROMEO 200 contenitore . storage unit
BIRK 80 specchio . mirror
TIMOTHY tavoli bassi . low tables
- p.12, 13 TIMOTHY 270 divano . sofa
TIMOTHY tavoli bassi . low tables
ROMEO 200 contenitore . storage unit
BIRK 80 specchio . mirror



03

- p.22 TERESINA LOUNGE KUOIO poltroncina . small armchair
RUBEN contenitore componibile . modular storage unit
- p.23 ROGER GHOST 260 divano . sofa
FRANK TB140 tavolo basso . low table
TERESINA KUOIO LOUNGE poltroncine . small armchairs
RUBEN contenitore componibile . modular storage unit
- p.24, 25 ROGER GHOST 260 divani . sofas
FRANK TB140 tavolo basso . low table
TERESINA KUOIO LOUNGE poltroncine . small armchairs
RUBEN contenitore componibile . modular storage unit
BOBO 45 tavoli bassi . low tables
- p.26 FRANK 115300TP tavolo . table
COSETTE sedie . chairs
- p.27 FRANK 115300TP tavolo . table
COSETTE sedie . chairs
HARDY pensile . wall unit
- p.28, 29 ROGER BOLD divano componibile . modular sofa
GONG 35 tavoli bassi . low tables
BONGO KUOIO TB4 tavolo basso . low table
FORREST SOFT poltroncina e pouf . small armchair and pouf
- p.30, 31 SCOTT letto . bed
CLUNY comodino . night table
NINA panchetta . bench
WALLIS UNO contenitore . storage unit
BIRK 220 specchio . mirror



02

- p.14 ROGER divano componibile . modular sofa
FRANK TB110 tavolo basso . low table
- p.15 FRANK TB110 tavolo basso . low table
ROGER divano componibile . modular sofa
ISABELLE poltroncine . small armchairs
- p.16, 17 VINCENT OPEN AIR chaise longue SQUARE
FABIEN OPEN AIR 70R tavolo basso . low table
- p.18, 19 RENÉ divano componibile . modular sofa
PEK UNO tavoli bassi . low tables
LEON 130 tavolo basso . low table
RENÉ poltroncine . small armchairs
BIRK 220 specchio . mirror
- p.20 HENRY scrittoio . writing desk
CLAUDINE sedia . chair
BIRK 220 specchio . mirror
- p.21 HENRY scrittoio . writing desk
CLAUDINE sedia . chair

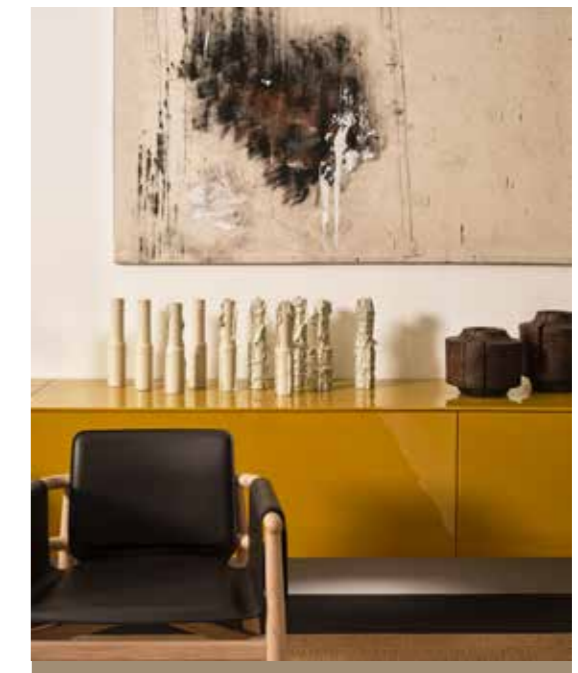

Roger

Roger è un sistema di sedute componibili che riesce ad accogliere nella sua semplicità. Essere semplice significa letteralmente “essere piegato una volta sola”. Ed è così che nasce il suo concept: da una superficie continua, quasi ininterrotta, che cambia direzione per avvolgere e assicurare nel suo comfort pieno. La struttura è lievemente arrotondata e invita a essere scoperta su ogni lato, rendendo questo prodotto ideale anche per soluzioni a centro stanza. I rivestimenti sono caratterizzati da un tessuto teso e cuciture che sottolineano la delicatezza e l'importanza delle forme del divano. I set di cuscini schienale conferiscono sostegno e bilanciano la generosa profondità delle sedute, definite da un cuscino intero accolto a incastro sotto al bracciolo. Nella versione Bold, Roger prevede l'aggiunta di un inserto in pelle che arricchisce la parte superiore dei braccioli e dello schienale, donando un aspetto esclusivo e sartoriale.

Roger is a modular seating system that manages to be welcoming in its simplicity. To be simple means literally “to be folded only once.” And that’s precisely how its concept was born: from a continuous, almost uninterrupted surface that changes direction to envelop and reassure with its deep, genuine comfort. The structure is slightly rounded and invites discovery from every side, making this product ideal even for central room solutions. The upholstery features taut fabric and stitching that emphasise the delicacy and importance of the sofa’s forms. The set of backrest cushions provides support and balances the generous depth of the seats, defined by a single cushion that fits snugly beneath the armrest. In the Bold version, Roger includes an additional leather insert that enriches the upper part of the armrests and backrest, bestowing an exclusive and tailored appearance.





ROGER

TECHNICAL DETAILS

IT	EN	DE	FR	ES
<ul style="list-style-type: none"> divani - elementi componibili sfoderabili (no liberi accostamenti di tessuto/pelle) fissi per versione in pelle struttura in legno staffe in metallo per fissaggio elementi imbottitura in poliuretano a densità differenziate e fibra poliestere cuscino seduta in poliuretano a densità differenziate con schiuma viscoelastica e fibra poliestere cuscino schienale in piuma supportata piedini neri in ABS <p>BOLD: con inserto in pelle P1 o P2 (no P3) - no versione tutta pelle</p> <p>divani e elemento realizzabili in larghezza solo in multipli di cm. 10: +5% per ogni 10 cm.</p>	<ul style="list-style-type: none"> sofas - modular units with removable cover (no free mixing of fabric/leather) fixed cover for leather version wooden frame metal brackets for modular units joining padding in polyurethane foam with different densities and polyester fiber seat cushion in polyurethane foam with different densities with viscoelastic foam and polyester fiber back cushion in reinforced feathers black ABS feet <p>BOLD: with leather insert cat. P1 - P2 (not P3) - not available for the fully leather version</p> <p>sofas and units can be customized in width only in multiples of 10 cm.: +5% for every 10 cm.</p>	<ul style="list-style-type: none"> Sofas - kombinierbare Elemente mit abziehbarem Bezug (keine freien Kombinationen von Stoff/ Leder) fester Lederbezug Holzgestell Metallverbindungen zur Befestigung der Anbauelemente Polsterung aus PU-Schäumen mit differenzierter Dichte und Polyesterfaser Sitzkissen aus PU-Schäumen mit differenzierter Dichte mit viskoelastischem Schaum und Polyesterfaser Rückenkissen aus Polyesterdaunen FüÙe ABS Schwarz <p>BOLD: mit Leder-Einsatz P1 - P2 (kein P3) - keine vollständige Leder-Version</p> <p>sofas und Elemente sind nur in der Breite von 10 cm-Multiplen erhältlich: +5% bei jede 10 cm</p>	<ul style="list-style-type: none"> canapés - éléments modulables déhoussables (pas d'associations libres de tissu/cuir) fixes pour version en cuir structure en bois plaque en métal pour fixation des éléments modulables rembourrage en polyuréthane à densités différenciées et fibre de polyester coussin assise en polyuréthane à densités différenciées avec mousse viscoélastique et fibre de polyester coussin dos en plumes renforcées pieds noirs en ABS <p>BOLD: avec insert en cuir P1 - P2 (pas P3) - pas de version tout cuir</p> <p>canapés et éléments réalisables en largeur uniquement par multiples de 10 cm.: +5 % pour chaque 10 cm.</p>	<ul style="list-style-type: none"> sofás - elementos modulares desenfundables (no combinaciones libres de tela/piel) funda fija para versión en piel estructura de madera abrazaderas en metal para fijación de elementos relleno en poliuretano con densidad diferenciada y fibra de poliéster cojín asiento en poliuretano con densidad diferenciada con espuma viscoelástica y fibra de poliéster cojín respaldo en pluma soportada patas negras en ABS <p>BOLD: con inserto en piel P1 - P2 (no P3) - no disponible en versión completamente en piel</p> <p>sofás y elementos se pueden personalizar en ancho solo en múltiplos de 10 cm.: +5% por cada 10 cm.</p>

divano - sofa 180

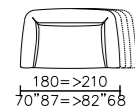
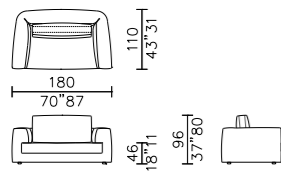

divano - sofa 220

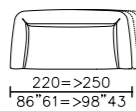
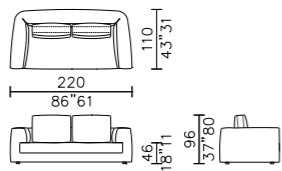

divano - sofa 260

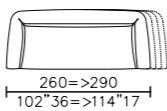
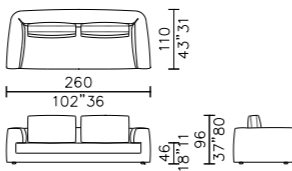

elemento - unit 160

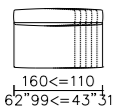
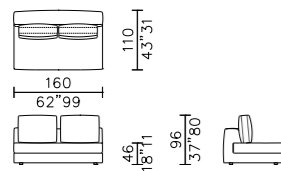

terminale - end unit 185

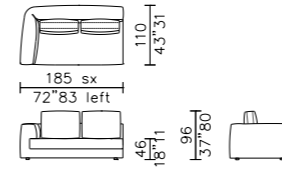

elemento angolo - corner unit 110

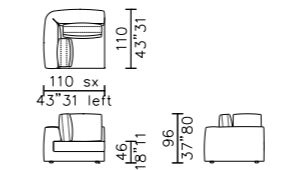

terminale - end unit 265

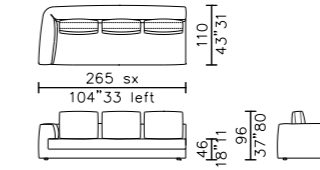

elemento angolo - corner unit 185

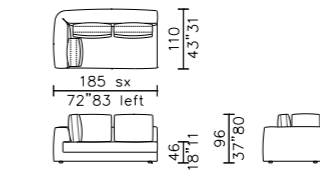

terminale angolo - end corner unit 290

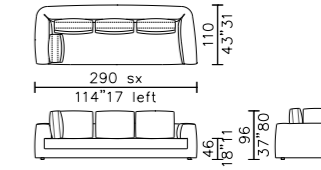

elemento angolo - corner unit 265

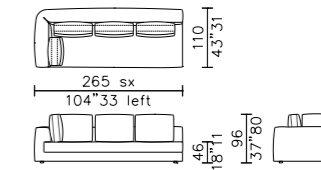

angolo penisola - penisula corner 245

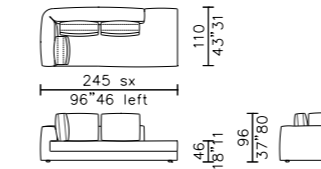

elemento penisola - penisula unit 220

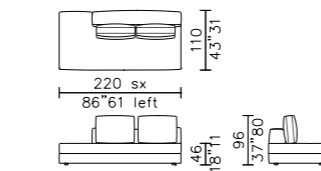

angolo penisola - penisula corner 325

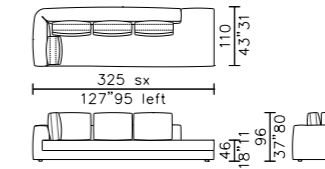

chaise longue

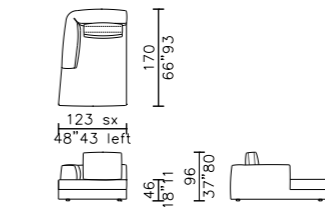

elemento penisola - penisula unit 140

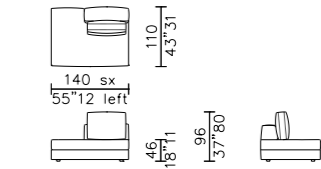

pouf

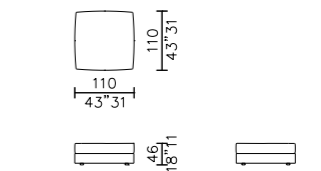

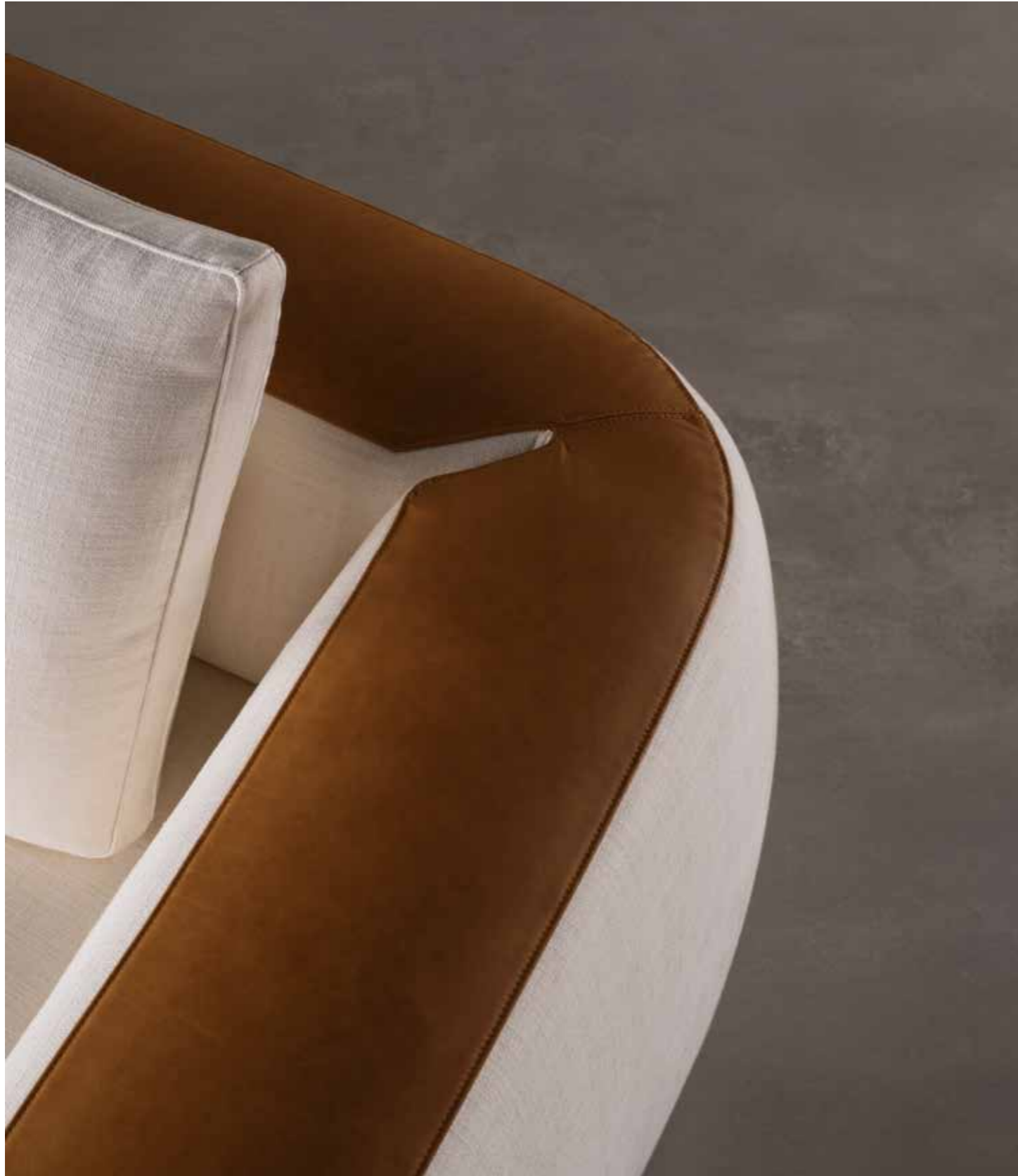

ROGER

SKETCHES OF CONFIGURATIONS

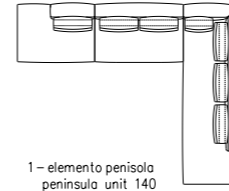

- 1 - elemento penisola
peninsula unit 140
- 1 - elemento
unit 160
- 1 - angolo penisola
corner peninsula 325

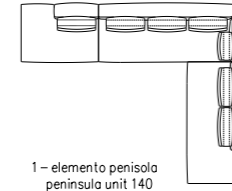

- 1 - elemento penisola
peninsula unit 140
- 1 - elemento angolo
corner unit 265
- 1 - elemento penisola
peninsula unit 220

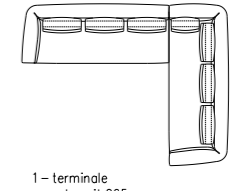

- 1 - terminale
end unit 265
- 1 - terminale angolo
end corner unit 290

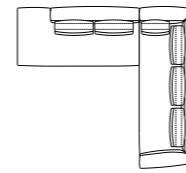

- 1 - elemento penisola
peninsula unit 220
- 1 - terminale angolo
end corner unit 290

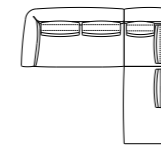

- 1 - terminale
end unit 185
- 1 - elemento angolo
corner unit 110
- 1 - elemento penisola
peninsula unit 140

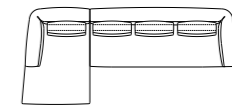

- 1 - chaise longue
end unit 265
- 1 - terminale
end unit 265

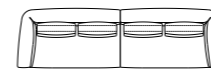

- 2 - terminale
end unit 185

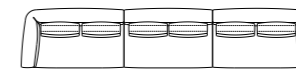

- 2 - terminale
end unit 185
- 1 - elemento
unit 160

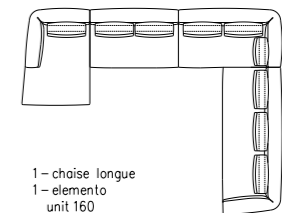

- 1 - chaise longue
end unit 265
- 1 - elemento
unit 160
- 1 - elemento angolo
corner unit 185
- 1 - terminale
end unit 265

Roger Ghost

Roger Ghost è un divano lineare che nasce dal sistema di sedute componibili Roger, con cui condivide il concept originario: accogliere nel suo “essere semplice” - etimologicamente, “essere piegato una sola volta” -, con una superficie continua, quasi ininterrotta, che cambia direzione per avvolgere in modo rassicurante, dentro un’eleganza disegnata da linee essenziali e morbide. La fodera, con una sapiente modellazione delle cuciture, cade libera e amplifica la morbidezza visiva del prodotto, armonizzandosi con cuscini schienale e decorativi realizzati con confezione a saponetta.

Roger Ghost is a linear sofa that evolves from the Roger modular seating system. It shares the original concept of welcoming simplicity - etymologically meaning “to be folded only once.” Its design features a continuous, almost uninterrupted surface that changes direction to create a reassuring embrace, all while maintaining an elegance defined by essential, soft lines. The cover, with its expertly crafted stitching, drapes freely and enhances the visual softness of the piece, harmoniously complementing both the backrest and decorative cushions with their refined pillow-like finish.







ROGER GHOST

TECHNICAL DETAILS

IT

- divani sfoderabili
- no versione in pelle
- struttura in legno
- imbottitura in poliuretano a densità differenziate e fibra poliestere
- cuscino seduta in poliuretano a densità differenziate con schiuma viscoelastica e fibra poliestere
- cuscino schienale - optional - in piuma supportata
- cuscino decorativo - optional - in piuma supportata
- piedini neri in ABS

divani realizzabili in larghezza solo in multipli di cm. 10: +5% per ogni 10 cm.

EN

- sofas with removable cover
- no leather version
- wooden frame
- padding in polyurethane foam with different densities and polyester fiber
- seat cushion in polyurethane foam with different densities with viscoelastic foam and polyester fiber
- back cushion - optional - in reinforced feathers
- deco cushion - optional - in reinforced feathers
- black ABS feet

sofas can be customized in width only in multiples of 10 cm.: +5% for every 10 cm.

DE

- abziehbare Sofas
- aus Leder nicht verfügbar
- Holzgestell
- Polsterung aus PU-Schäumen mit differenzierter Dichte und Polyesterfaser
- Sitzkissen aus PU-Schäumen mit differenzierter Dichte mit viskoelastischem Schaum und Polyesterfaser
- Rückenkissen - extra - aus Polsterdaunen
- Dekokissen - extra - aus Polsterdaunen
- Füße ABS Schwarz

Sofas sind nur in der Breite von 10 cm-Multiplen erhältlich: +5% bei jede 10 cm

FR

- canapés déhoussables
- pas de version en cuir
- structure en bois
- rembourrage en polyuréthane à densités différenciées et fibre de polyester
- coussin assise en polyuréthane à densités différenciées avec mousse viscoélastique et fibre de polyester
- coussin dos - optionnel - en plumes renforcées
- coussin deco - optionnel - en plumes renforcées
- pieds noirs en ABS

canapés réalisables en largeur uniquement par multiples de 10 cm.: +5 % pour chaque 10 cm.

ES

- sofás desenfundables
- no disponible en piel
- estructura de madera
- relleno en poliuretano con densidad diferenciada y fibra de poliéster
- cojín asiento en poliuretano con densidad diferenciada con espuma viscoelástica y fibra de poliéster
- cojín respaldo - opcional - en pluma soportada
- cojín decorativo - opcional - en pluma soportada
- patas negras en ABS

sofás se pueden personalizar en ancho solo en múltiplos de 10 cm.: +5% por cada 10 cm.

divano - sofa 180

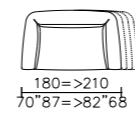
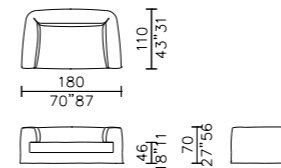

divano - sofa 220

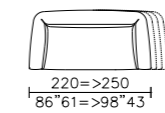
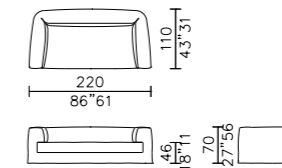

divano - sofa 260

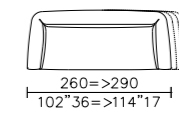
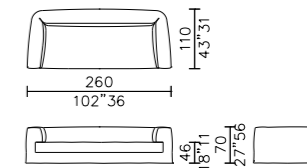

cuscino schienale - back cushion 115

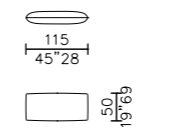

cuscino schienale - back cushion 75

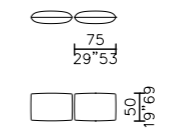

cuscino schienale - back cushion 95

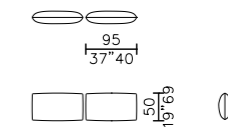

pouf 110

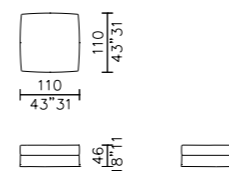

cuscino DECO - cushion DECO 55

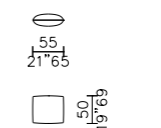

Jeanette

Jeanette è la poltrona dalle morbide forme scultoree. A un anno dal suo lancio, la collezione è già pronta per arricchirsi, accogliendo la versione divanetto: con linee floride ma compatte, Jeanette loveseat è in grado di portare comodità e note di chiaro stile sia in ambienti residenziali sia in contesti contract.

Jeanette is the armchair with soft sculptural forms. Just one year after its launch, the collection is already expanding, welcoming the loveseat version: with voluptuous yet compact lines, Jeanette loveseat brings comfort and clear stylistic notes to both residential settings and contract environments.

48

JEANETTE 2025

love seat NEW

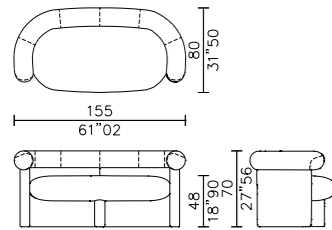

poltrona - armchair

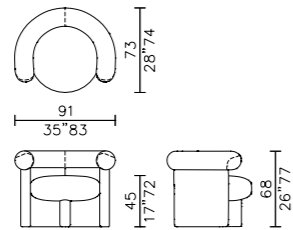

TECHNICAL DETAILS

IT

- poltrona e love seat imbottite non sfoderabili in una selezione di tessuti di collezione
- struttura in legno
- imbottiture in poliuretano e fibre poliestere
- gamba centrale in massello di faggio tinto black - laccato opaco/ lucido o rivestita in una selezione di tessuti di collezione (stesso tessuto della struttura)

EN

- padded armchair and love seat with fixed cover in a selection of Meridiani fabrics
- wooden frame
- padding in polyurethane and polyester fiber
- legs in solid beech black stained, in rigid polyurethane matt or glossy lacquered - covered in a selection of Meridiani fabrics (same fabric as the frame)

DE

- gepolsterte Sessel und Love Seat mit Festbezug aus einer Auswahl von Meridiani Stoffen
- Holzgestell
- Polsterung aus PU-Schäumen und Polyesterfaser
- Füße aus massiv Buchenholz black gebeizt, aus hartem Polyurethan matt/Hochglanz lackiert oder mit Bezug aus einer Auswahl von Meridiani Stoffen (gleicher Stoff wie Gestell)

FR

- fauteuil et love seat rembourrés pas déhoussables dans une sélection des tissus Meridiani
- structure en bois
- embouillage en polyuréthane et fibre polyester
- pieds en hêtre massif teinté noir, en polyuréthane rigide laque mate ou brillante ou dans une sélection des tissus Meridiani (même tissu que la structure)

ES

- butaca y love seat acolchadas con funda fija en una selección de telas Meridiani
- estructura de madera
- relleno en poliuretano y fibra poliéster
- patas de haya maciza teñida en negro, de poliuretano rígido lacadas mate o brillo - tapizadas en una selección de telas Meridiani (misma tela que la estructura)

49



Frank

La collezione di tavoli Frank porta in casa l'equilibrio progettuale. Il piano, sottile nell'estetica ma robusto nella consistenza, è sostenuto da tiranti longitudinali in metallo e sorretto da gambe che, dal basso, si slanciano per abbracciarlo alle estremità. Questa giunzione a vista diventa dettaglio iconico della collezione, richiamando il design delle sedie Cosette e del pouf Gino, complementi perfetti per creare un ambiente completo e stilisticamente coerente. Il tavolo Frank ha gambe smussate e longilinee, ed è disponibile in tre formati rettangolari, fino a 3 metri di lunghezza. Con un concetto di design monomaterico, tutti i tavoli Frank sono configurabili completamente in rovere fiammato o in una selezione di finiture laccate.

The Frank table collection brings design equilibrium into the home. The tabletop combines sleek aesthetics with robust substance. It rests on longitudinal metal braces, while elegant legs extend upward to embrace it at each end. This visible junction becomes the iconic detail of the collection, echoing the design of the Cosette chairs and Gino pouffe - perfect complements for creating a complete and stylistically coherent environment. The Frank table features tapered, elongated legs and is available in three rectangular formats, up to 3 metres in length. Following a mono-material design concept, all Frank tables can be configured entirely in flamed oak or in a selection of lacquered finishes.



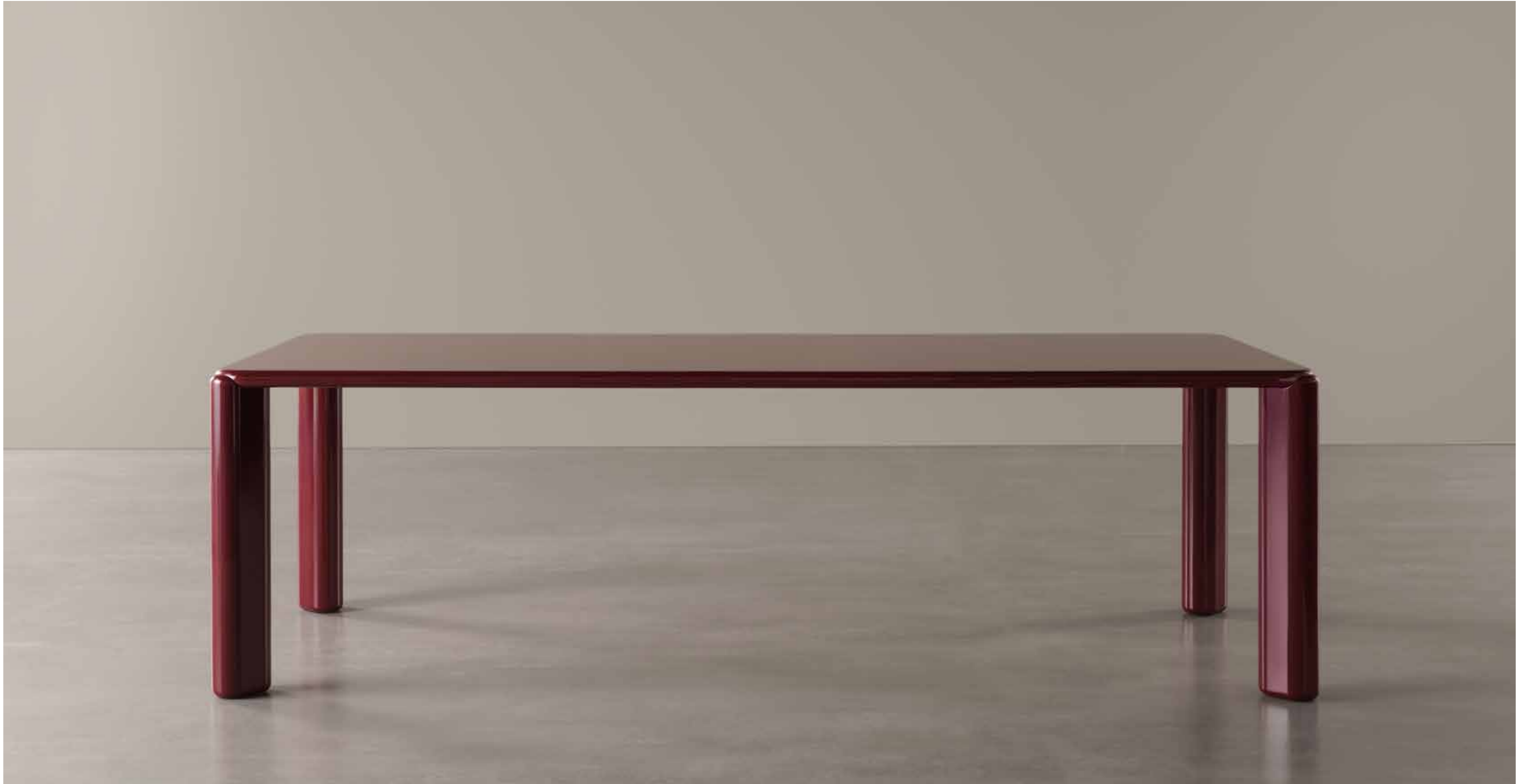



FRANK

TECHNICAL DETAILS

IT	EN	DE	FR	ES
<ul style="list-style-type: none"> tavoli finiture piani e gambe: impiallacciatura rovere fiammato tinto black, moro, tobacco, almond, light (stesso colore) lacca opaca o lucida nei colori selezionati chalk, lava e cherry (stesso colore e finitura) 	<ul style="list-style-type: none"> tables finishes: flamed oak veneer black, moro, tobacco, almond, light stained (single colour) matt or glossy lacquer only in colours chalk, lava and cherry (single colour and finish) 	<ul style="list-style-type: none"> Tische Ausführungen: Furnier aus flammigem Eichenholz, black, moro, tobacco, almond, light gebeizt (gleiche Farbe) Lack matt oder Hochglanz nur in der Farben chalk, lava und cherry (gleiche Farbe und Ausführung) 	<ul style="list-style-type: none"> tables finitions: placage en chêne flammé teinté black, moro, tobacco, almond, light (même couleur) laque mate ou brillante uniquement dans les couleurs chalk, lava et cherry (même couleur et finition) 	<ul style="list-style-type: none"> mesas acabados: enchapado en roble flameado teñido black, moro, tobacco, almond, light (mismo color) laca mate o brillo solo en los colores chalk, lava y cherry (mismo color y acabado)
finiture: vedi campionario	finishes: see sample box	Einzig verfügbare Maße	finitions: voir boîte d'échantillons	acabados: véase el muestrario
tavoli realizzabili in lunghezza solo in multipli di cm. 10: +20% per ogni 10 cm.	tables can be customized in length only in multiples of 10 cm: +20% for every 10 cm.	Tische sind nur in der Länge von 10 cm-Multiplen erhältlich: +20% bei jede 10 cm	tables réalisables en longueur uniquement par multiples de 10 cm.: +20% pour chaque 10 cm.	mesas se pueden personalizar en largo solo en múltiplos de 10 cm.: +20% por cada 10 cm.
non sollevare mai il tavolo dopo averlo fissato al basamento	never lift the table after fixing the top to the base	Nie den Tisch nach der Befestigung von Tischplatte am Gestell heben	ne jamais soulever la table après avoir fixé le plateau à la base	nunca levantar la mesa por el sobre después de fijarla a la base

tavolo pranzo - dining table 95200-TP

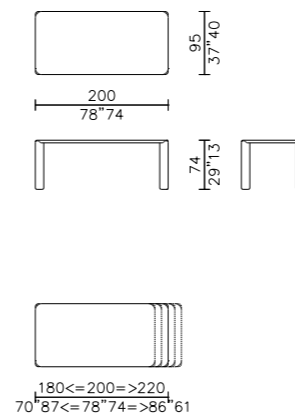

tavolo pranzo - dining table 105250-TP

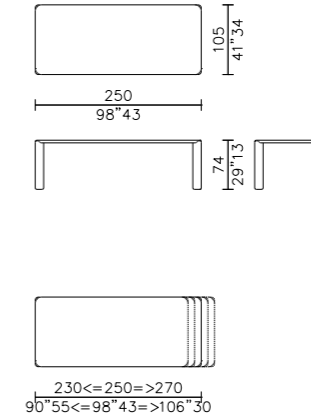

tavolo pranzo - dining table 115300-TP

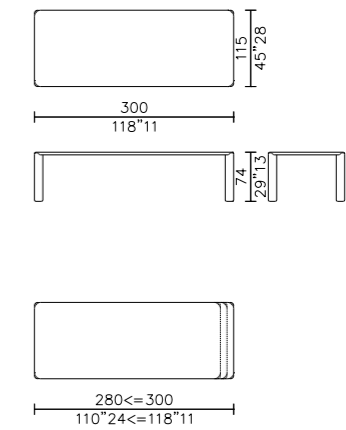

Adrian

Collezione di tavoli bassi dalla peculiare forma del piano, che si assottiglia sul perimetro e che sembra quasi sospeso nel vuoto, grazie alla snella struttura in metallo. Realizzati in differenti dimensioni, i tavolini Adrian sono disponibili con top in lacca lucida e opaca o nelle diverse varianti di marmo. Per le versioni quadrate e rettangolari, è ora possibile avere i top di Adrian anche in legno di rovere fiammato.

A collection of coffee tables with a distinctive top shape that tapers at the perimeter and appears almost suspended in space, thanks to the slender metal structure. Crafted in different dimensions, Adrian coffee tables are available with tops in glossy and matt lacquer or in various marble options. For the square and rectangular versions, Adrian tops are now also available in flamed oak wood.

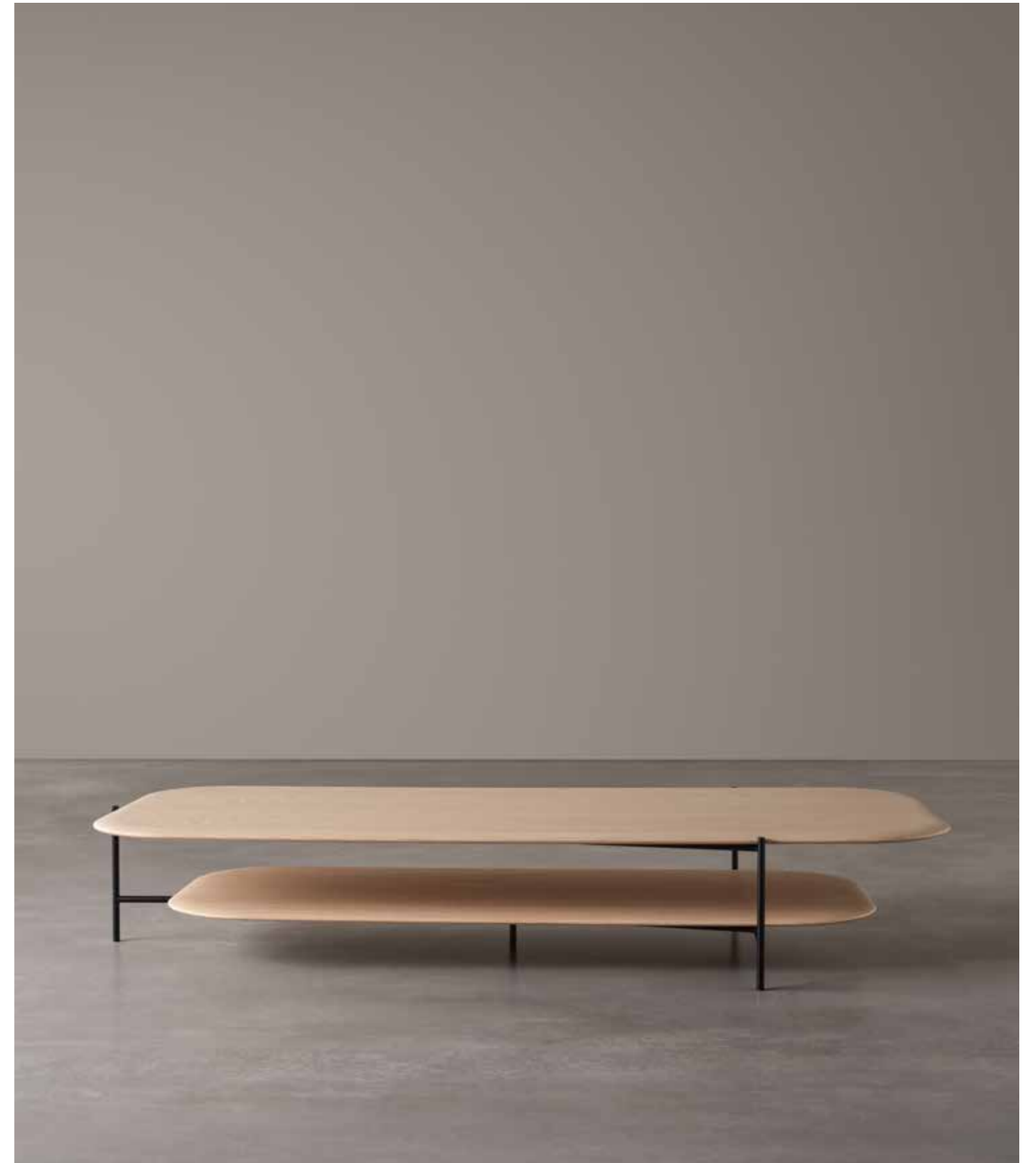



ADRIAN

TECHNICAL DETAILS

IT	EN	DE	FR	ES
<ul style="list-style-type: none"> tavoli bassi struttura tubolare in metallo finiture struttura: verniciato ottone bronzato varnished opaco black varnished opaco black con puntale in ottone piani con sagomatura perimetrale finiture piani: impiallacciatura rovere fiammato tinto black, moro, tabacco, almond, light lacca opaca o lucida marmo MR1, MR2 o MR3 (non disponibile per versione 35R e 45) marmo MR1, MR2 o MR3 piano superiore + lacca opaca o lucida piano inferiore 	<ul style="list-style-type: none"> low tables tube metal frame frame finishes: varnish in bronzed brass black matt varnished black matt varnished with tip in bronzed brass shaped tops finishes for tops: flamed oak veneer black, moro, tobacco, almond, light stained matt or glossy lacquer marble MR1, MR2 or MR3 (not available on models 35R and 45) marble MR1, MR2 or MR3 for upper top + matt or glossy lacquer for lower top 	<ul style="list-style-type: none"> Beistelltische Rohrgestell aus Metall Ausführungen für das Gestell: varnished in der Farbe Messing bronziert varnished schwarz matt varnished schwarz matt mit Messingspitze geformte Platte Platte Ausführungen: Furnier aus flammigem Eichenholz, black, moro, tabacco, almond, light gebeizt Lack matt oder Hochglanz Marmor MR1, MR2 oder MR3 (nicht verfügbar für Modell 35R und 45) Marmore MR1, MR2 oder MR3 für die obere Platte + Lack Hochglanz oder matt für die untere Platte 	<ul style="list-style-type: none"> tables basses structure tubulaire en métal finitions structure: verni couleur laiton bronzé verni mat black verni mat black avec embout en laiton plateaux ronds sur le périmètre finitions des plateaux: placage chêne flammé teinté black, moro, tabacco, almond, light laque mate ou brillante marbre MR1, MR2 ou MR3 (pas disponible pour versions 35R et 45) marbre MR1, MR2 ou MR3 dessus supérieur + laque mate ou brillante dessus inférieur 	<ul style="list-style-type: none"> mesitas estructura tubular en metal acabados estructura: barnizados latón bronceado barnizado mate black barnizado mate black con punta en latón sobres perfilados acabados sobres: enchapado en roble flameado teñido black, moro, tabacco, almond, light lacado mate o brillo mármol MR1, MR2 o MR3 (no disponible para mod. 35R y 45) sobre superior en mármol MR1, MR2 o MR3 + sobre inferior en laca mate o brillo
<p>finiture: vedi campionario</p>	<p>finishes: see sample box</p>	<p>Ausführungen: siehe Musterbox</p>	<p>finitions: voir boîte d'échantillons</p>	<p>acabados: véase el muestrario</p>

tavolo basso - low table 35R

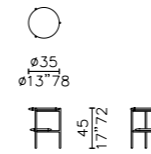

tavolo basso - low table 50R

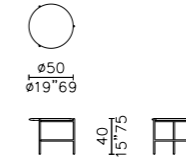

tavolo basso - low table 70R

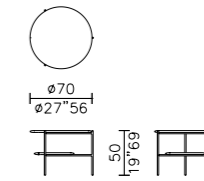

tavolo basso - low table 130R

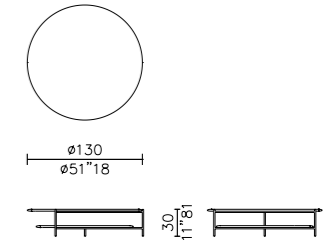

tavolo basso - low table 45

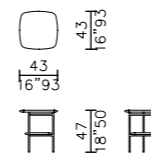

tavolo basso - low table 55

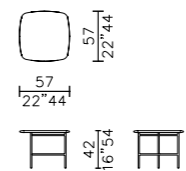

tavolo basso - low table 75

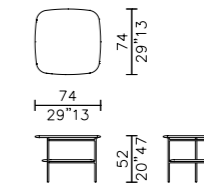

tavolo basso - low table 85180

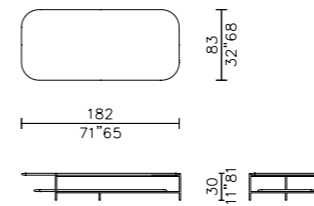

tavolo basso - low table 130

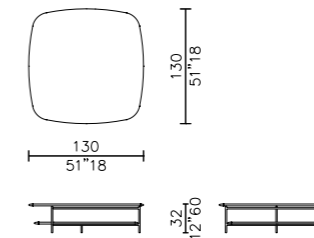

Frank

Con precisione di linee e solidità materica, i tavoli bassi Frank condividono il disegno fondante dei tavoli da pranzo appartenenti alla stessa collezione. Il piano sottile ma robusto è iconicamente abbracciato alle estremità dalla terminazione di gambe scultoree, che conferiscono un aspetto più monolitico al prodotto. I tavoli bassi Frank sono disponibili in versione quadrata o rettangolare, in rovere fiammato o in tutte le nuance di lacche lucide e opache.

With precision of lines and material solidity, the Frank coffee tables share the foundational design of the dining tables belonging to the same collection. The slender yet robust tabletop is elegantly cradled at each end by sculptural legs, giving the piece a more monolithic appearance. Frank coffee tables are available in square or rectangular versions, in flamed oak or in all shades of glossy and matt lacquers.





FRANK

TECHNICAL DETAILS

IT	EN	DE	FR	ES
<ul style="list-style-type: none"> tavoli bassi finiture piani e gambe: impiallacciatura rovere fiammato tinto black, moro, tobacco, almond, light (stesso colore) lacca opaca o lucida (stesso colore e finitura) 	<ul style="list-style-type: none"> low tables finishes: flamed oak veneer black, moro, tobacco, almond, light stained (single colour) matt or glossy lacquer (single colour and finish) 	<ul style="list-style-type: none"> Beistelltische Ausführungen: Furnier aus flammigem Eichenholz, black, moro, tobacco, almond, light gebeizt (gleiche Farbe) Lack matt oder Hochglanz (gleiche Farbe und Ausführung) 	<ul style="list-style-type: none"> tables basses finitions: placage chêne flammé teinté black, moro, tobacco, almond, light (même couleur) laque mate ou brillante (même couleur et finition) 	<ul style="list-style-type: none"> mesitas acabados: enchapado en roble flameado teñido black, moro, tobacco, almond, light (mismo color) laca mate o brillo (mismo color y acabado)
finiture: vedi campionario	finishes: see sample box	Ausführungen: siehe Musterbox	finitions: voir boîte d'échantillons	acabados: véase el muestrario
uniche dimensioni	fixed dimensions	Einzig verfügbare Maße	seules dimensions	únicas medidas

tavolo basso - low table TB-110

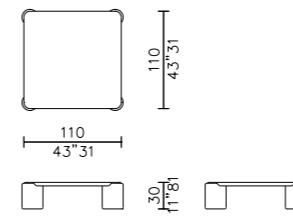

tavolo basso - low table TB-140

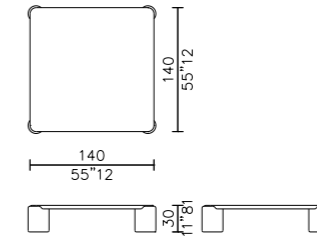

tavolo basso - low table TB-80180

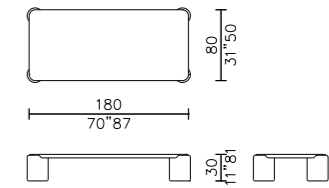

Henry

Henry è uno scrittoio a tre gambe, un tavolo visivamente sinuoso, con una sagoma morbida che, nel punto di giuntura tra gambe e piano, richiama il disegno dei tavoli e tavolini Frank. Progettato per essere un punto di appoggio tanto pratico per la casa quanto funzionale in ufficio, la caratteristica curvatura del piano accoglie la seduta e dona alla stanza un tocco di armonia ricercata. Il tutto viene valorizzato ulteriormente dalle possibili finiture laccate lucide o opache - in tutti i colori di collezione -, in grado di rendere accattivante un angolo di lavoro così come raffinata una postazione privata a uso domestico. Come accessorio opzionale, un sottomano in cuoio.

Henry is a three-legged writing desk, a visually sinuous table with a soft silhouette that, at the junction point between legs and top, echoes the design of the Frank tables and coffee tables. Designed to be a practical support for the home as well as functional in the office, the characteristic curvature of the top accommodates the seat and gives the room a touch of refined harmony. The design is further elevated by the range of glossy or matt lacquered finishes available in all collection colours, which can transform a simple work corner into an appealing space or create a sophisticated personal workstation within the home. A leather desk pad is available as an optional accessory.





HENRY

TECHNICAL DETAILS

IT	EN	DE	FR	ES
<ul style="list-style-type: none"> • scrittoio • finiture piano e gambe: lacca opaca o lucida (stesso colore e finitura) • sottomano - optional - in cuoio 	<ul style="list-style-type: none"> • writing desk • finishes: matt or glossy lacquer (single colour and finish) • desk pad - optional - in leather 	<ul style="list-style-type: none"> • Schreibtisch • Ausführungen: Lack matt oder Hochglanz (gleiche Farbe und Ausführung) • Matte aus Kernleder - extra 	<ul style="list-style-type: none"> • ecritoire • finitions: laque mate ou brillante (même couleur et finition) • sous-main en cuir sellier - optionnel 	<ul style="list-style-type: none"> • escritorio • acabados: laca mate o brillo (mismo color y acabado) • tapete en cuero - opcional
<p>finiture: vedi campionario</p> <p>uniche dimensioni</p>	<p>finishes: see sample box</p> <p>fixed dimensions</p>	<p>Ausführungen: siehe Musterbox</p> <p>Einzig verfügbare Maße</p>	<p>finitions: voir boîte d'échantillons</p> <p>seules dimensions</p>	<p>acabados: véase el muestrario</p> <p>únicas medidas</p>

scrittoio - writing desk

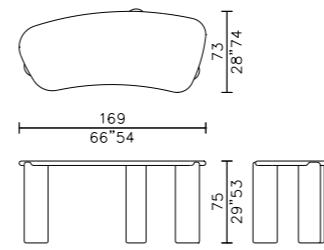

sottomano - desk pad A

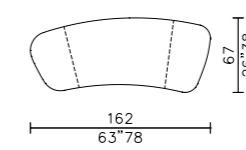

sottomano - desk pad B

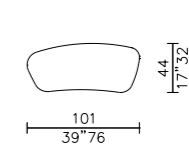

MATE

TECHNICAL DETAILS

IT	EN	DE	FR	ES
<ul style="list-style-type: none"> quadri con doppio orientamento (orizzontale e verticale) completo di supporti per fissaggio a muro finiture disponibili: lacca lucida nei colori selezionati brick e lava su fronte e sui bordi lamiera acciaio inox lucido su fronte e sui bordi legno impiallacciato rovere tinto light 	<ul style="list-style-type: none"> artworks with double orientation (horizontal and vertical) fittings for wall mounting included finishes: glossy lacquer in colours brick and lava (on front and edges) glossy stainless steel (on front and edges) light stained oak veneer 	<ul style="list-style-type: none"> Bilder mit doppelter Ausrichtung (horizontal und vertikal) Befestigungsbeschläge für Wandmontage Ausführungen: Lack Hochglanz nur in den Farben brick und lava (an der Vorderseite und an den Kanten) Eiche Furnier, light gebeizt 	<ul style="list-style-type: none"> tableaux avec double orientation (horizontale et verticale) complet avec supports pour fixation au mur finitions: laque brillante uniquement dans les couleurs brick et lava (sur le devant et sur les bords) platinum steel brillante (sur le devant et sur les bords) placage en chêne teinté light 	<ul style="list-style-type: none"> cuadros con doble orientación (horizontal y vertical) soportes para fijación a la pared incluidos acabados: laca brillo en los colores brick y lava (en el frente y los bordes) acero inoxidable brillo (en el frente y en los bordes) enchapado en roble teñido light

mate 50x70

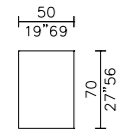

mate 85x160

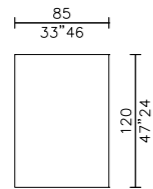

mate 115x160

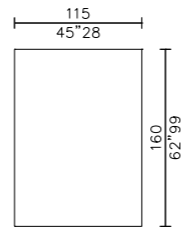

FINITURE . FINISHING



glossy stainless steel lava glossy lacquer brick glossy lacquer light stained oak veneer

NAPA

TECHNICAL DETAILS

IT	EN	DE	FR	ES
<ul style="list-style-type: none"> collezione di tappeti in fibra poliammidica, realizzati con la tecnica della taffatura a mano tinta unita in 4 varianti colore: ghiaccio, ostrica, tortora e beige altezza superficie ± 17 mm. 	<ul style="list-style-type: none"> collection of hand-tufted polyamide fiber rugs plain colours in 4 shades: ice, oyster, taupe and beige pile height ± 17 mm. 	<ul style="list-style-type: none"> Teppichkollektion aus Polyamidfaser, Handtuft Uni-Farbe in 4 Farbvarianten: Eis, Muschel, Taupe und Beige Florhöhe ± 17 mm. 	<ul style="list-style-type: none"> collection de tapis en fibre polyamide, tuftés à la main uni en 4 variantes de couleur : glace, huître, taupe et beige hauteur de la surface ± 17 mm. 	<ul style="list-style-type: none"> colección de alfombras de fibra poliamida, tufting a mano color liso en 4 variantes: hielo, ostra, topo y beige altura pelo ± 17 mm.

napa 170x230

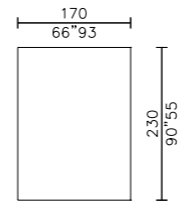

napa 200x300

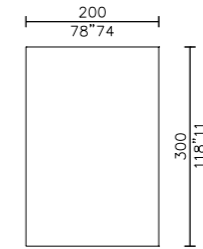

napa 250x350

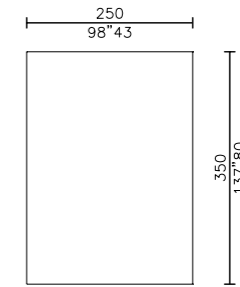

napa 300x400

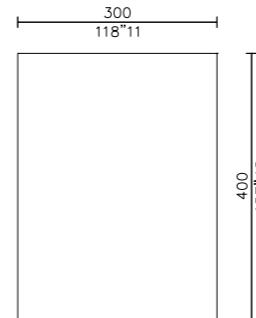

FINITURE . FINISHING



ghiaccio ostrica beige tortora

FINITURE . FINISHING

lacca opaca e lucida . matt and glossy lacquer



rovere fiammato tinto . flamed oak wood

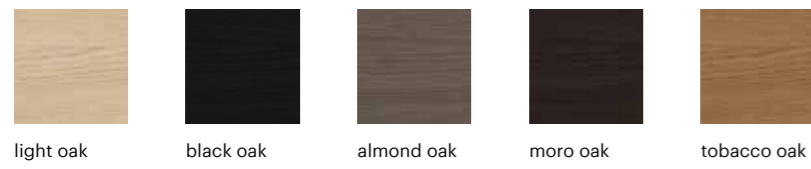

cuoio . saddle leather



metallo . metal

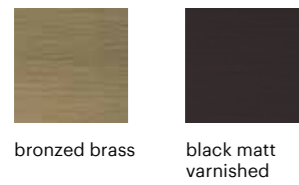

marmo . marble

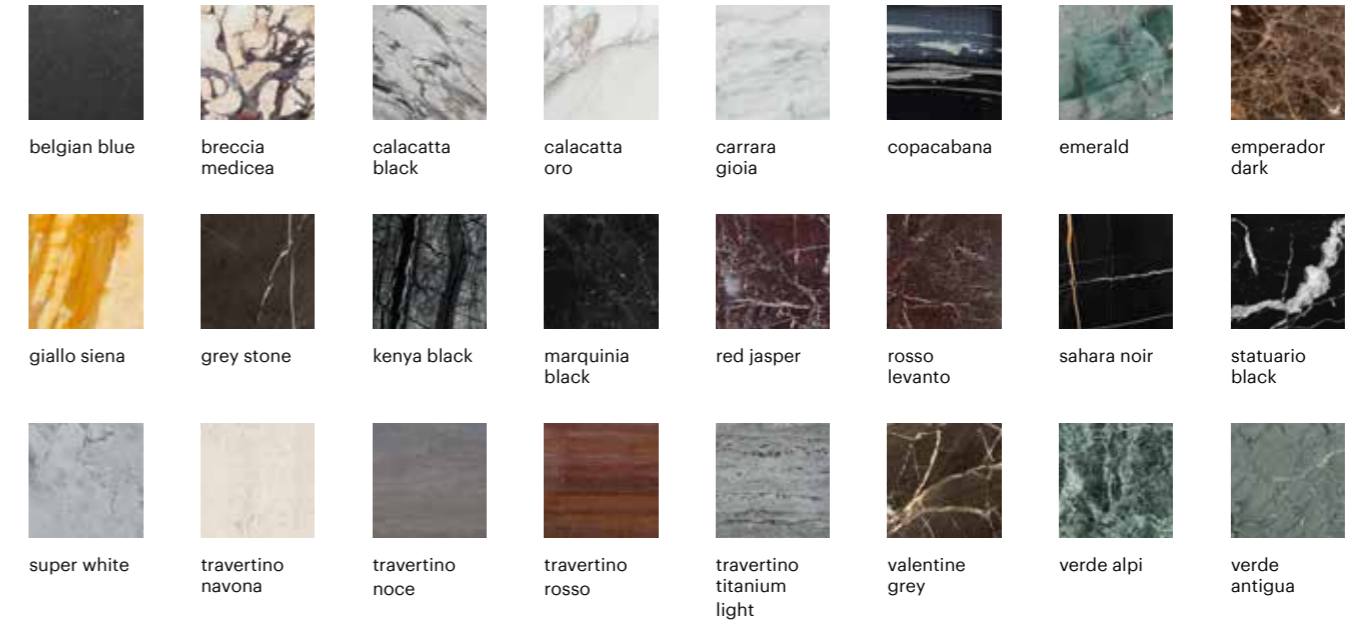

Art Direction / Andrea Parisio

Graphic and Concept Image / YAM112003

Photo / Davide Lovatti

Styling / Laura Tocchet

Printed in Italy by / Euroteam, April 2025

MERIDIANI SRL
20826 MISINTO ITALY
VIA BIRAGO, 16
TEL +39 02 96 69 161
INFO@MERIDIANI.IT
MERIDIANI.IT



#MeridianiLivingInteriors

© MERIDIANI SRL
COPYRIGHT 1998
APRIL 2025

Le immagini riprodotte su questo catalogo sono un suggerimento di configurazioni, per le caratteristiche tecniche e dimensioni consultare l'area riservata del nostro sito meridiani.it Meridiani srl si riserva la facoltà di modificare, in qualunque momento e senza preavviso, le caratteristiche tecniche ed estetiche dei modelli illustrati nel presente catalogo. I prodotti Meridiani sono 100% made in italy.

The products displayed in this catalogue are to be considered as sample configurations. For any technical specifications and/or dimensions, please visit the reserved area of our website meridiani.it Meridiani srl reserves the right to modify, at any time and without prior notice, the technical and aesthetic characteristics of the models shown in this catalogue. Meridiani products are 100% made in italy.

my home is ME
MERIDIANI

meridiani.it